

**Kit poignée**

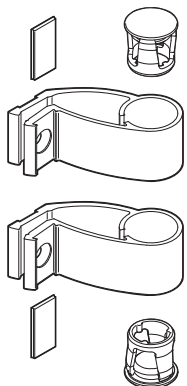

**Barreau**



**1** Recouper le barreau  
(bien ébavurer les bords) ;

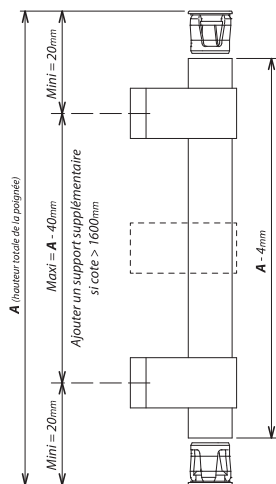
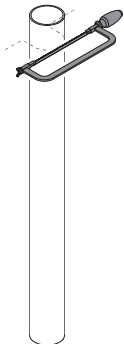

**2** Placer les bouchons sur le barreau ;



**3** Bloquer les bouchons ;

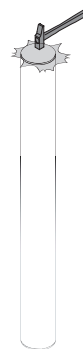

**Kit pied supplémentaire**

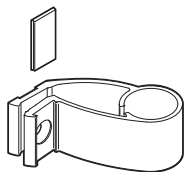

**Fixation non traversante pour 1 poignée**

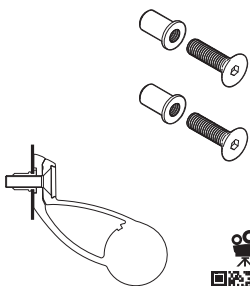

**1** Percer le profil ;

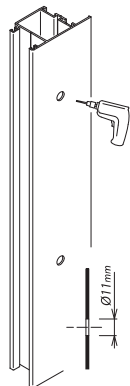

**2** Placer puis serrer les écrous ;

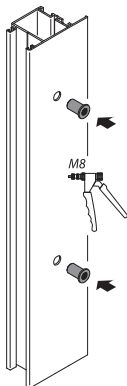

**3** Positionner les supports et les vis sur le profil ;  
(Attention, ne pas serrer à fond et ne pas bloquer le barreau)

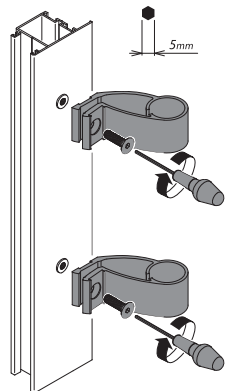

**4** Régler la position du barreau ;

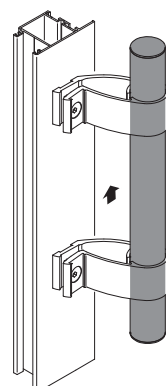

**5** Serrer définitivement les vis de fixation ;

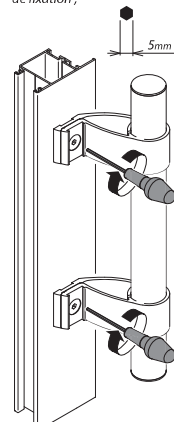

**6** Placer les cache-vis.

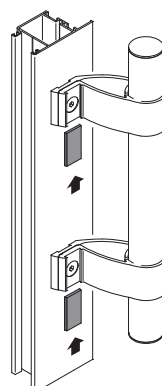

### Fixation traversante pour 1 poignée

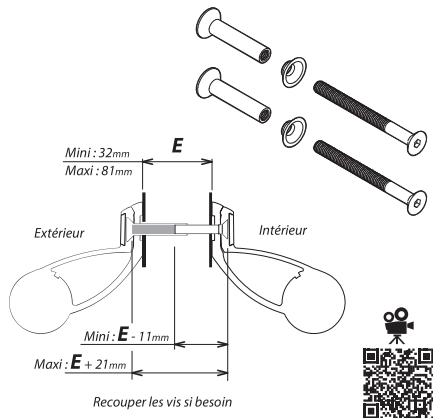

**1** Percer le profil ;

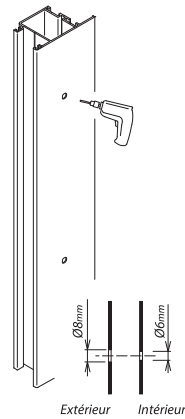

**2** Positionner les supports et les fixations sur le profil ;  
(Attention, ne pas serrer à fond et ne pas bloquer le barreau)

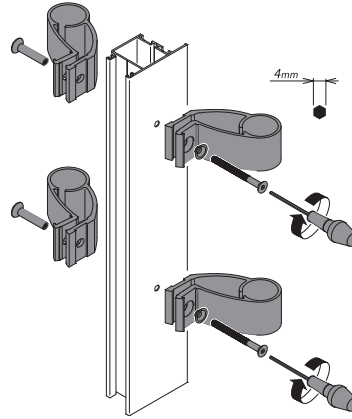

**3** Régler la position des barreau ;

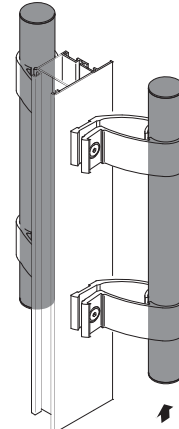

**4** Serrer définitivement les vis de fixation ;

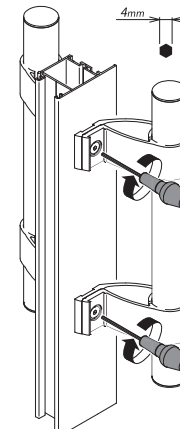

**5** Placer les cache-vis.

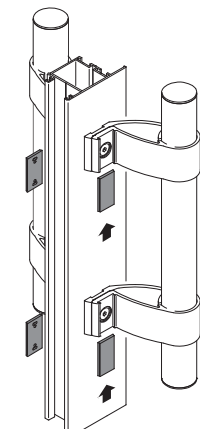

### Fixation traversante pour 2 poignées

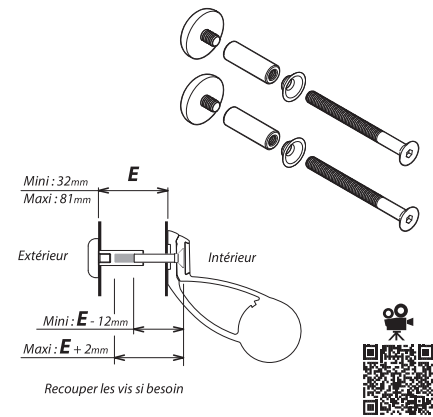

**1** Percer le profil ;

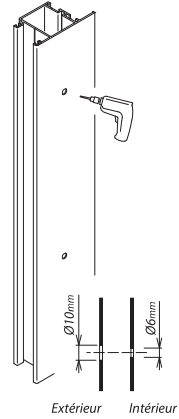

**2** Positionner les supports et les fixations sur le profil (Attention, ne pas serrer à fond et ne pas bloquer le barreau) ;

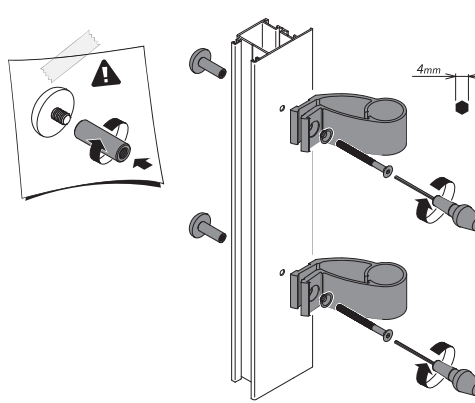

**3** Régler la position du barreau ;

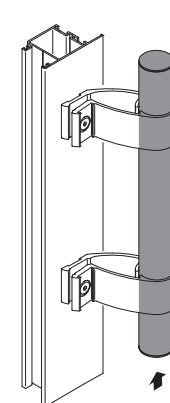

**4** Serrer définitivement les vis de fixation ;

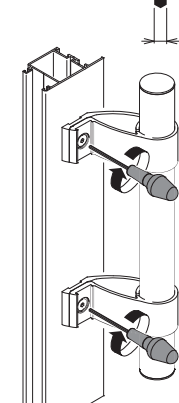

**5** Placer les cache-vis.

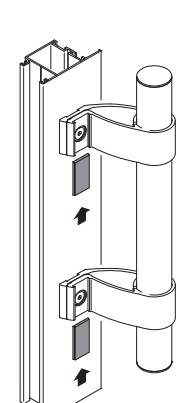

### Fixation traversante pour 2 poignées sur porte en verre

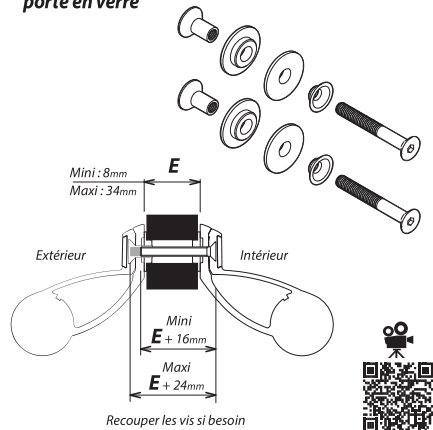

**1** Percer le profil ;

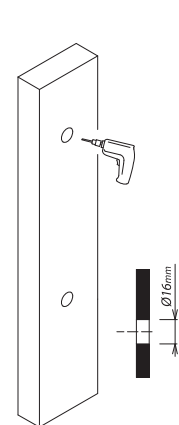

**2** Positionner les supports et les fixations sur le profil ;  
(Attention, ne pas serrer à fond et ne pas bloquer le barreau)

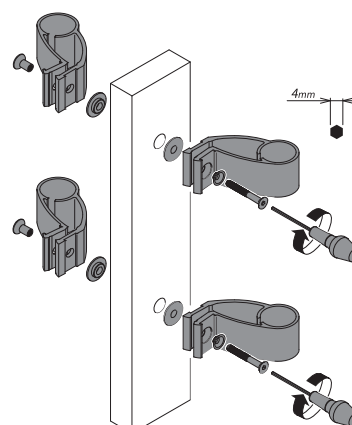

**3** Régler la position des barreau ;

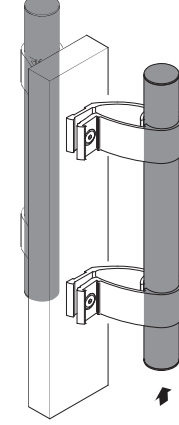

**4** Serrer définitivement les vis de fixation ;

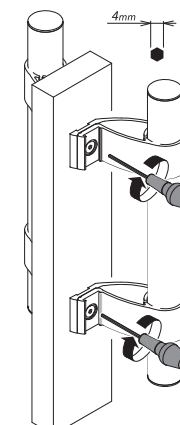

**5** Placer les cache-vis.

